

GENERAL DESCRIPTION

The BM9209 is the improvement version of CM2838 in I_q , in dropout, also in PSRR for portable wireless products. BM9209 family is a positive voltage linear regulator developed utilizing CMOS technology featured low quiescent current ($5\mu A$ typ.) and $0.1\mu A$ standby current, lowest dropout voltage, and high output voltage accuracy, making them ideal for battery applications. EN input connected to CMOS has low bias current. Integrated current limit and temperature limit protection circuit.

These rugged devices have both Thermal Shutdown, and Current Fold-back to prevent device failure under the "Worst" of operating conditions.

In application requiring a low noise, regulated supply, place a $1000pF$ capacitor between Bypass and Ground.

The BM9209 is stable with an output capacitance of $1.0\mu F$ or greater.

FEATURES

- ◆ Very Low Dropout Voltage : $160mV @200mA$
- ◆ Low Current Consumption: $5\mu A$
- ◆ Output Voltage: 1.8V, 2.5V, 2.8V, 3.0V, 3.3V
- ◆ High Accuracy Output Voltage: $\pm 1.5\%$
- ◆ Guaranteed 300mA Output
- ◆ Input Range up to 7.0V
- ◆ Thermal Shutdown and Current Limiting
- ◆ Fast enable turn-on time of $20\mu s$ (typ.)
- ◆ Compact Package: SOT-23-5
- ◆ Factory Pre-set Output Voltages
- ◆ Short Circuit Current Fold-Back
- ◆ Low standby(off) current : $0.1\mu A$
- ◆ Higher PSRR : 60dB (1KHz)
- ◆ Improved from RT9193, CM2838 and RT9167

APPLICATIONS

- ◆ PHS, mobile phone
- ◆ Wireless lan
- ◆ Wireless telephone
- ◆ Digital Camera
- ◆ Portable GPS
- ◆ MP4, portable DVD

TYPICAL APPLICATIONS

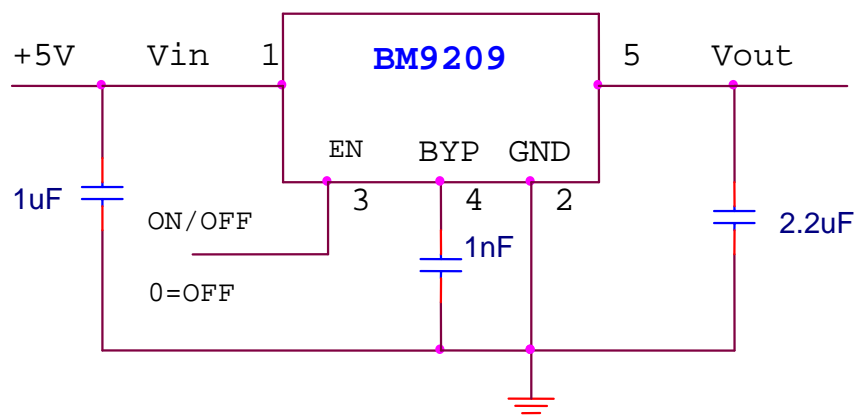

PIN CONFIGURATION

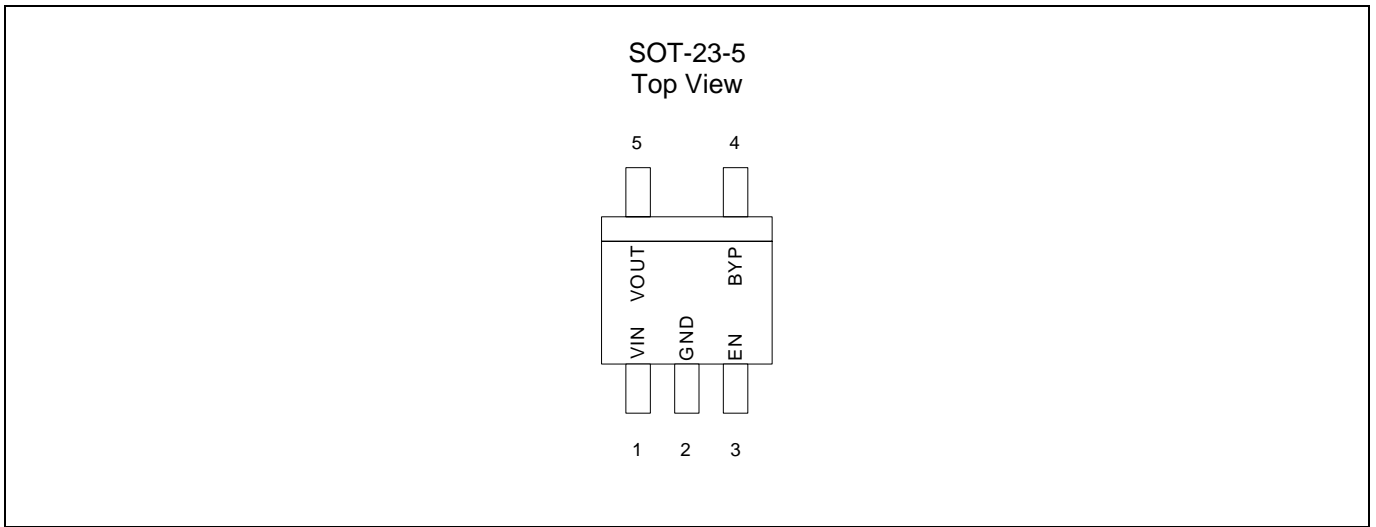

BLOCK DIAGRAM

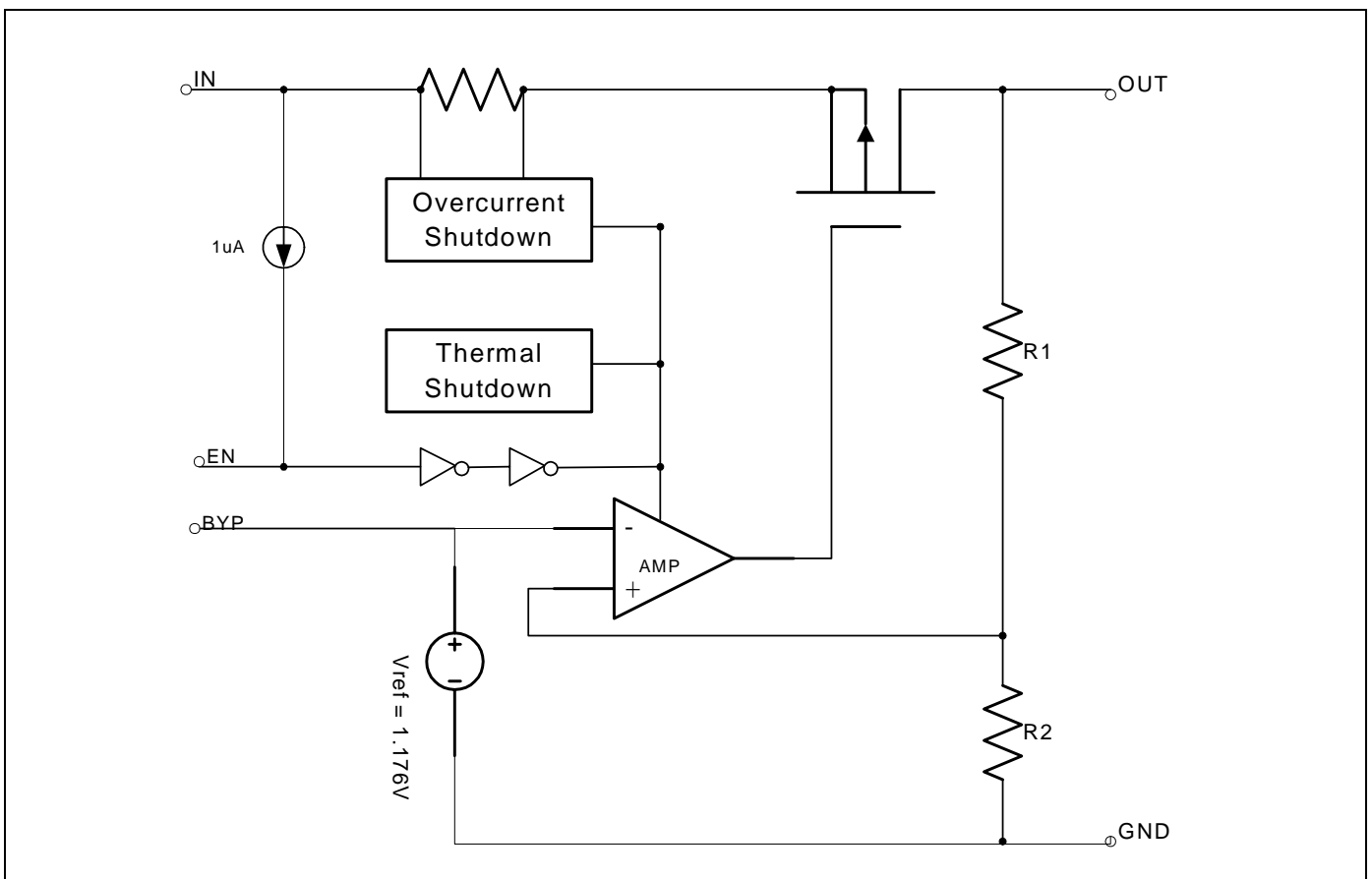

ORDERING INFORMATION

Part Number	Output Voltage	Temperature Range	Package
BM9209GDIM25	1.8V	-40°C ~ +85°C	SOT-23-5
BM9209GKIM25	2.5V	-40°C ~ +85°C	SOT-23-5
BM9209GNIM25	2.8V	-40°C ~ +85°C	SOT-23-5
BM9209GPIM25	3.0V	-40°C ~ +85°C	SOT-23-5
BM9209GSIM25	3.3V	-40°C ~ +85°C	SOT-23-5

Note: For other pre-set output voltage requirements, please contact Bookly Sales office.

ABSOLUTE MAXIMUM RATINGS

Input Voltage +8.5V
 Output Current $P_D / (V_{IN} - V_o)$ mA
 Output Voltage GND-0.3V to $V_{IN}+0.3V$
 ESD Classification B

OPERATING RATINGS

Ambient Temperature Range (T_A) -40°C to +85°C
 Junction Temperature Range -40°C to +125°C

THERMAL INFORMATION

Parameter		Maximum	Unit
Thermal Resistance (θ_{jc})	SOT-23-5	160	°C/W
Internal Power Dissipation (P_D) ($\Delta T = 100^\circ\text{C}$)	SOT-23-5	320	°C/W
Maximum Junction Temperature		150	°C
Maximum Lead Temperature (10 Sec)		300	°C

Caution: Stress above the listed absolute rating may cause permanent damage to the device.

BM9209

300mA CMOS LDO WITH ENABLE

ELECTRICAL CHARACTERISTICS

$T_A = +25^\circ\text{C}$; unless otherwise noted

Parameter	Symbol	Test Conditions	BM9209			Unit
			Min.	Typ.	Max.	
Input Voltage	V_{IN}		Note 1		8	V
Output Voltage Accuracy	V_{OUT}	$I_O = 1\text{mA}$	-1.5		1.5	%
Dropout Voltage	$V_{DROPOUT}$	$I_O = 300\text{mA}$, $V_{OUT} = V_{O(NOM)} - 2\%$	$1.2\text{V} < V_{O(NOM)} \leq 2.0\text{V}$	400		mV
			$2.0\text{V} < V_{O(NOM)} \leq 2.5\text{V}$	200		mV
			$2.5\text{V} < V_{O(NOM)}$	150		mV
Output Current	I_O	$V_{OUT} > 1.2\text{V}$	250	300		mA
Current Limit	I_{LIM}	$V_{OUT} > 1.2\text{V}$	300	450		mA
Short Circuit Current	I_{SC}	$V_{OUT} < 0.95\text{V}$		400	450	mA
Quiescent Current	I_Q	$I_O = 0\text{mA}$		5	7	μA
Ground Pin Current	I_{GND}	$I_O = 1\text{mA}$ to 400mA		5	7	μA
Line Regulation	REG_{LINE}	$I_{OUT} = 5\text{mA}$, $V_{IN} = V_{OUT} + 1$ to $V_{OUT} + 2$		0.015	0.2	%
Load Regulation	REG_{LOAD}	$I_O = 1\text{mA}$ to 400mA		0.2	1.5	%
Over Temperature Shutdown	OTS			150		$^\circ\text{C}$
Over Temperature Hysteresis	OTH			30		$^\circ\text{C}$
V_{OUT} Temperature Coefficient	TC			40		ppm/ $^\circ\text{C}$
Power Supply Rejection	PSRR	$I_O = 100\text{mA}$ $C_O = 2.2\ \mu\text{F}$ ceramic	$f = 1\text{kHz}$	60		dB
			$f = 10\text{kHz}$	55		
			$f = 100\text{kHz}$	50		
Power Supply Rejection	PSRR	$I_O = 100\text{mA}$ $C_O = 2.2\ \mu\text{F}$ ceramic $C_{BYP} = 0.01\ \mu\text{F}$	$f = 1\text{kHz}$	65		dB
			$f = 10\text{kHz}$	62		
			$f = 100\text{kHz}$	60		
Output Voltage Noise	eN	$f = 10\text{Hz}$ to 100kHz $I_O = 10\text{mA}$, $C_{BYP} = 0\ \mu\text{F}$	$C_O = 2.2\ \mu\text{F}$	20		μV_{rms}
			$C_O = 100\ \mu\text{F}$	15		
Output Voltage Noise	eN	$f = 10\text{Hz}$ to 100kHz $I_O = 10\text{mA}$, $C_{BYP} = 0.01\ \mu\text{F}$	$C_O = 2.2\ \mu\text{F}$	17		μV_{rms}
			$C_O = 100\ \mu\text{F}$	10		
Shutdown Supply Current	I_{SD}	$V_{IN} = 5.0\text{V}$, $V_{OUT} = 0\text{V}$, $V_{EN} < V_{EL}$		0.1	0.3	μA
EN Input Bias Current	I_{EH}	$V_{EN} = V_{IN}$, $V_{IN} = 2.6\text{V}$ to 7V			0.1	μA
	I_{EL}	$V_{EN} = 0$, $V_{IN} = 2.6\text{V}$ to 7V		0.1	0.3	μA
EN Input Threshold	V_{EH}	$V_{IN} = 2.6\text{V}$ to 7V	(Note2)		V_{IN}	V
	V_{EL}	$V_{IN} = 2.6\text{V}$ to 7V	0		0.4	V

Note 1. $V_{IN(MIN)} = V_{OUT} + V_{DROPOUT}$

Note 2. Based on our design architecture, the enable input threshold will depend on the input voltage. To ensure the stability of your design application, please set the $V_{EH(MIN)} = V_{IN}/2 + 0.8\text{V}$.

DETAILED DESCRIPTION

The BM9209 family of CMOS regulators contain a PMOS pass transistor, voltage reference, error amplifier, over-current protection, thermal shutdown, and short circuit protection.

The P-channel pass transistor receives data from the error amplifier, over-current shutdown, short output protection, and thermal protection circuits. During normal operation, the error amplifier compares the output voltage to a precision reference. Over-current and Thermal shutdown circuits become active when the junction temperature exceeds 150°C, or the current exceeds 400mA. During thermal shutdown, the output voltage remains low. Normal operation is restored when the junction temperature drops below 120°C.

The BM9209 switches from voltage mode to current mode when the load exceeds the rated output current. This prevents over-stress. The BM9209 also incorporates current fold-back to reduce power dissipation when the output is short-circuited. This feature becomes active when the output drops below 1.05V, and reduces the current flow by 65%. Full current is restored when the voltage exceeds 0.95V.

ENABLE

The Enable pin normally floats high. When pulled down low voltage, switch off output, the PMOS pass transistor shut off, and all internal circuits are powered down. In this state, the quiescent current is less than 0.1 μ A. This pin behaves much like an electronic switch.

EXTERNAL CAPACITOR

The BM9209 is stable with an output capacitor to ground of 1.0 μ F or greater. It can keep stable even with higher or poor ESR capacitors. A second capacitor is recommended between the input and ground to stabilize VIN. The input capacitor should be larger than 0.1 μ F to have a beneficial effect. All capacitors should be placed in close proximity to the pins. A "quiet" ground termination is desirable.

TYPICAL ELECTRICAL CHARACTERISTICS

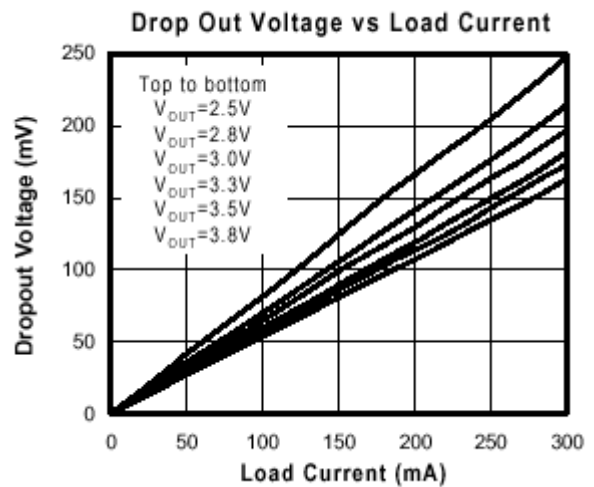
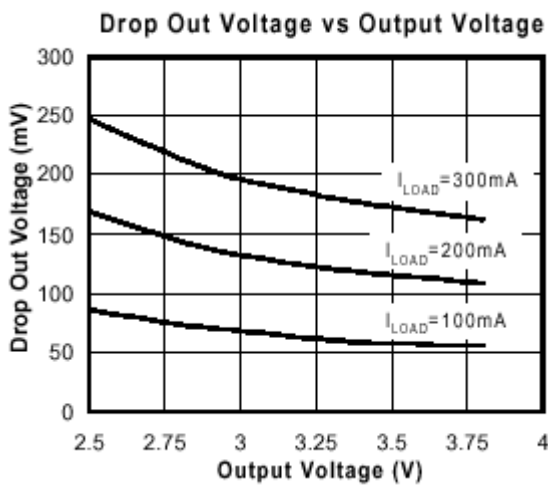
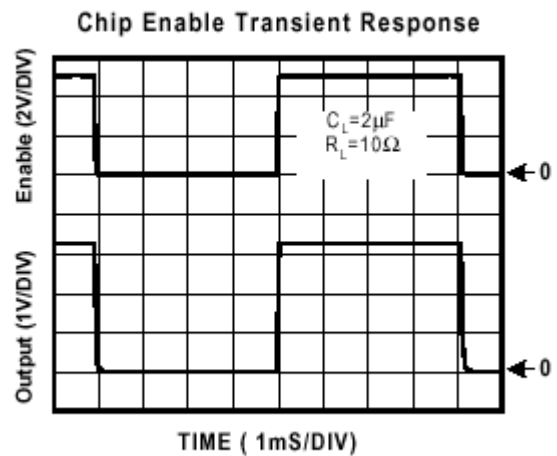
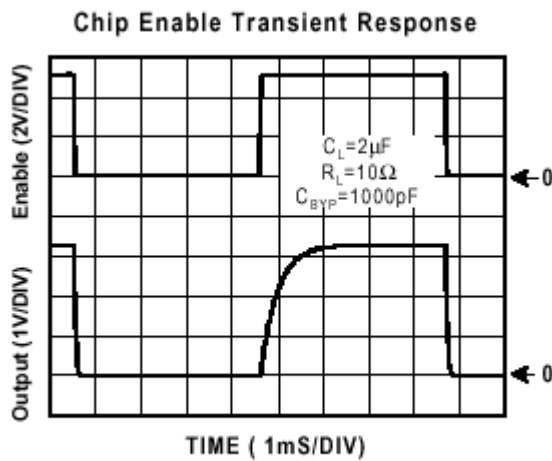
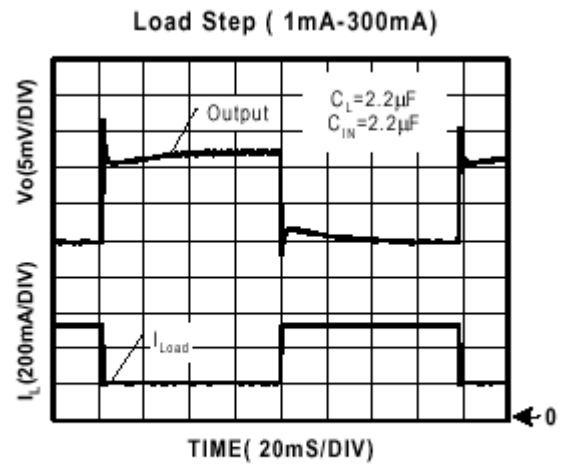
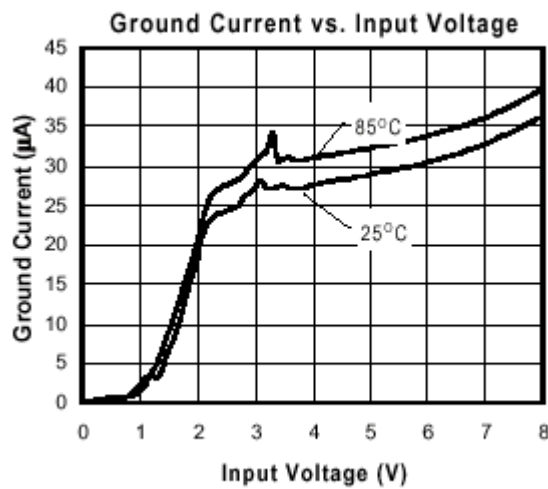

BM9209

300mA CMOS LDO WITH ENABLE

Short Circuit Response

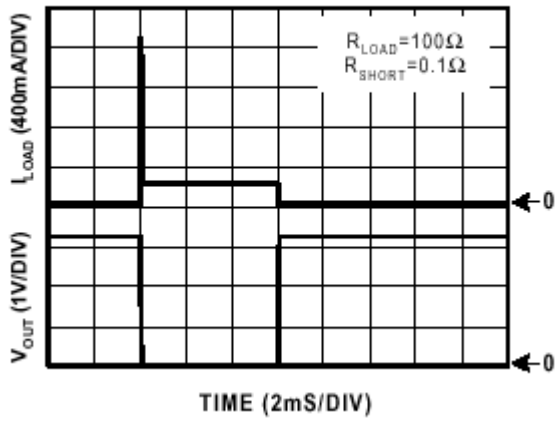

Overtemperature Shutdown

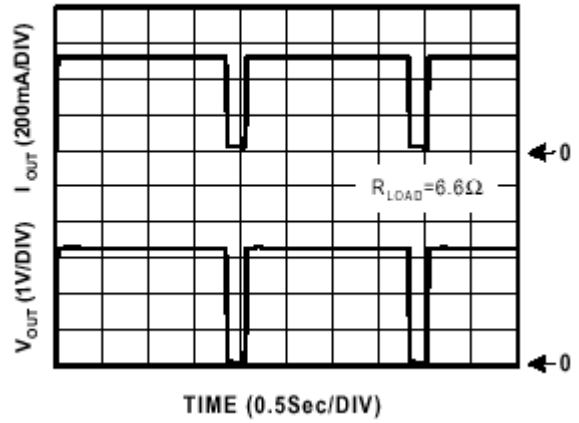

Current Limit Response

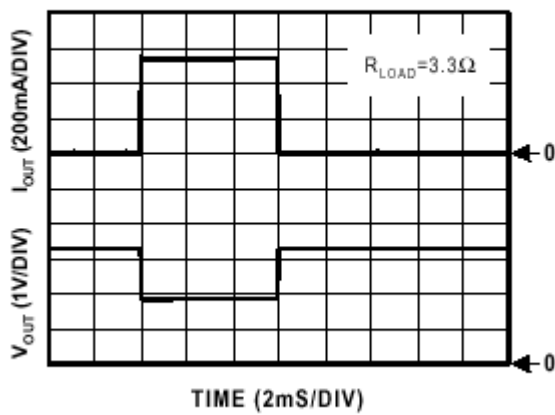

Noise Measurement

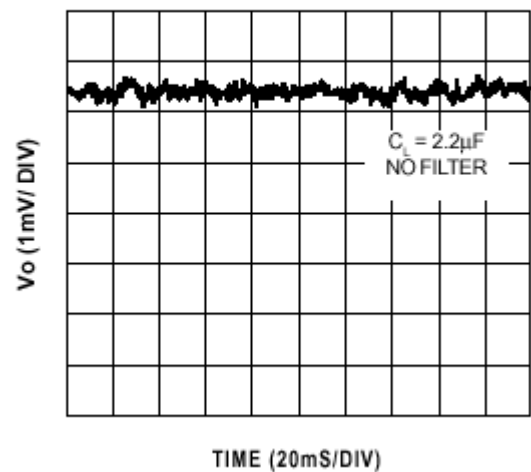

Transient Line Response

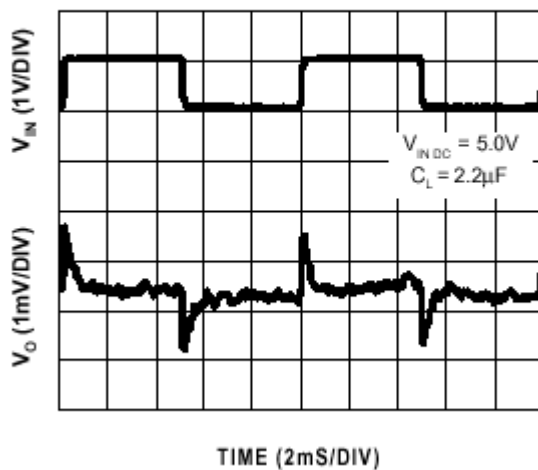

Safe Operating Area

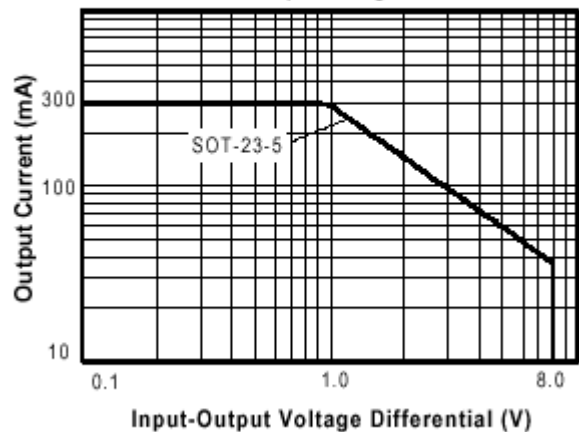

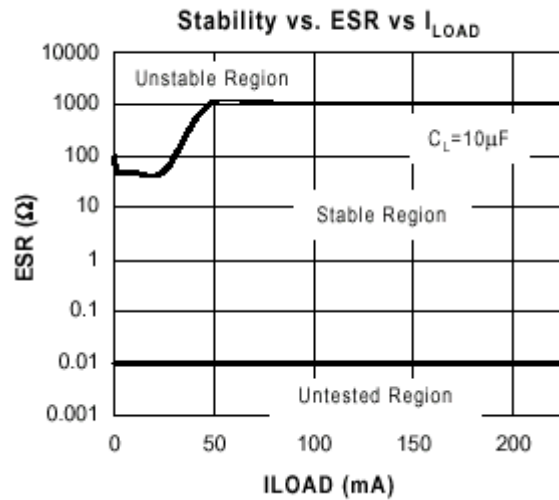
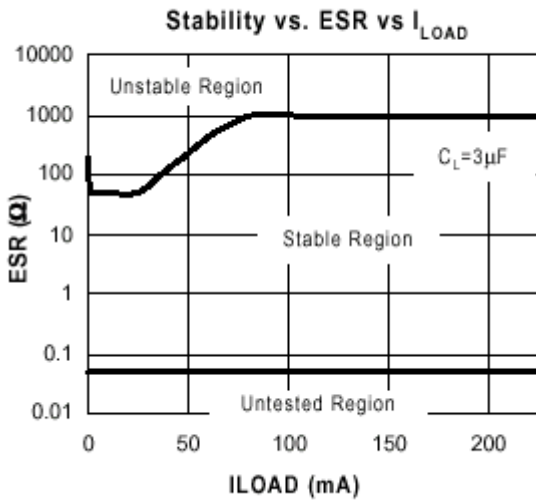
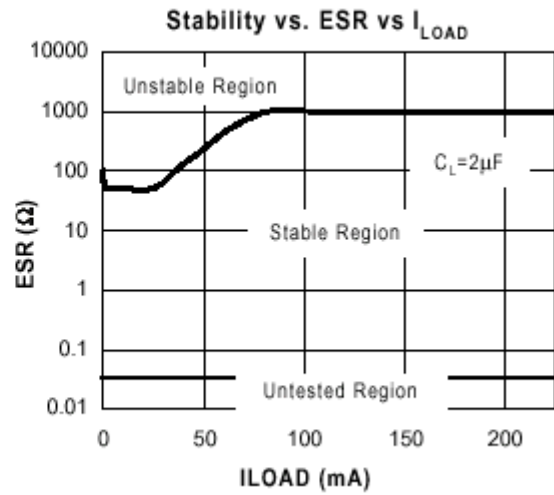
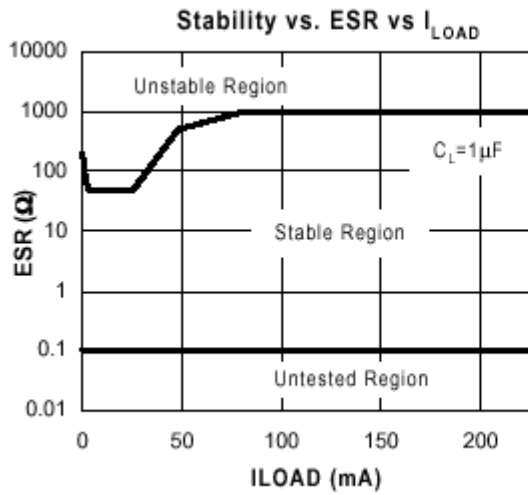

PACKAGE DIMENSION

SOT-23-5 (M25)

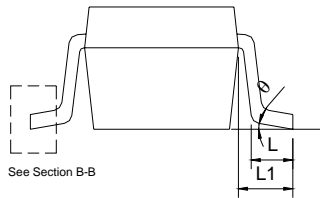
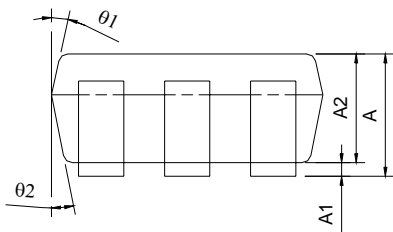
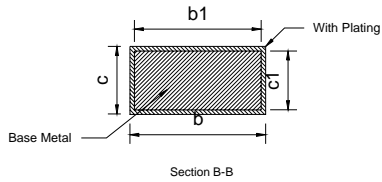
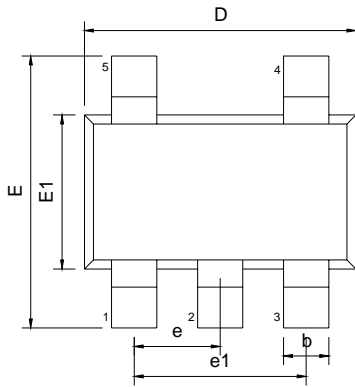

SYMBOLS	DIMENSIONS IN MILLIMETERS			DIMENSIONS IN INCHES		
	MIN	NOM	MAX	MIN	NOM	MAX
A	1.05	---	1.35	0.041	---	0.053
A1	0.05	---	0.15	0.002	---	0.006
A2	1.00	1.10	1.20	0.039	0.043	0.047
b	0.25	---	0.50	0.010	---	0.020
b1	0.25	0.40	0.45	0.010	0.016	0.018
c	0.08	---	0.20	0.003	---	0.008
c1	0.08	0.11	0.15	0.003	0.004	0.006
D	2.70	2.90	3.00	0.106	0.114	0.118
E	2.60	2.80	3.00	0.102	0.110	0.118
E1	1.50	1.60	1.70	0.059	0.063	0.067
L	0.35	0.45	0.55	0.014	0.018	0.022
L1	0.60 REF			0.024 REF		
e	0.95 BSC			0.037 BSC		
e1	1.90 BSC			0.075 BSC		
theta	0°	5°	10°	0°	5°	10°
theta1	3°	5°	7°	3°	5°	7°
theta2	6°	8°	10°	6°	8°	10°